

evolution®

www.evolutionpowertools.com

R210
CMS

Original Instructions

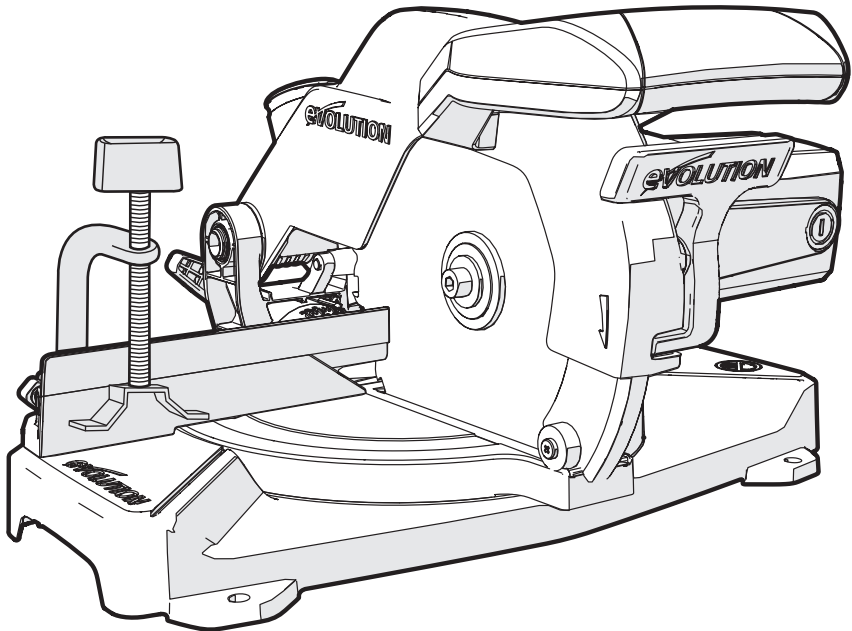

TABLE OF CONTENTS

Introduction	Page 3
Guarantee	Page 3
Machine Specifications	Page 4
Labels and Symbols	Page 5
Intended use of this Power Tool	Page 6
Prohibited use of this Power Tool	Page 6
Safety Precautions	Page 6
Electrical Safety	Page 6
Outdoor Use	Page 6
Power Tool General Safety Instructions	Page 6
Health Advice	Page 8
Mitre Saw Specific Safety	Page 9
Blade Safety	Page 9
Personal Protective Equipment (PPE)	Page 9
Safe Operation	Page 9
Perform Cuts Correctly and Safely	Page 10
Additional Safety Advice - Carrying your Mitre Saw	Page 10
Getting Started	Page 11
Unpacking	Page 11
Serial No. / Batch Code	Page 11
Items Supplied	Page 11
Additional Accessories	Page 11
Machine Overview	Page 12
Assembly and Preparation	Page 13
Permanently Mounting the Mitre Saw	Page 13
For Portable Use	Page 13
Hold Down Clamp	Page 14
The Sliding Upper Fence Section	Page 14

Operating Instructions	Page 14
Body and Hand Positioning	Page 15
Adjustment of Precision Angles	Page 15
Bevel Angles	Page 15
Cutting Head Travel	Page 16
Fence Alignment	Page 16
Mitre Angle Scales & Pointer	Page 17
Final Adjustment Checks	Page 17
Preparing to Make a Cut	Page 17
Releasing the Cutting Head	Page 17
The Motor On/Off Switch	Page 18
Chop Cutting	Page 18
Mitre Cutting	Page 18
Bevel Cutting	Page 19
Tilting the Cutting Head	Page 19
Compound Cutting	Page 19
Cutting Bowed Material	Page 20
Clearing Jammed Material	Page 20
Supporting Long Workpieces	Page 20
Installing or Removing a Blade	Page 20
Use of Optional Evolution Accessories	Page 21
Dust Bag	Page 21
Maintenance	Page 22
Environmental Protection	page 22
Declaration of Conformity	Page 23

INTRODUCTION

(1.2)

This instruction manual was originally written in English.

(1.3)

IMPORTANT

Please read these operating and safety instructions carefully and completely. For your own safety, if you are uncertain about any aspect of using this equipment please access the relevant technical helpline. The number of which can be found on the Evolution Power Tools website. We operate several helplines throughout our worldwide organization, but technical help is also available from your supplier.

WEB:

www.evolutionpowertools.com

EMAIL:

enquiries@evolutionpowertools.com

(1.4)

Congratulations on your purchase of an Evolution Power Tools machine. Please complete your product guarantee registration online as explained in the guarantee registration leaflet included with this machine. You can also scan the QR code found on the leaflet with a smart phone. This will enable you to validate your machine's guarantee period via Evolution's website by entering your details and thus ensure prompt service if ever needed. We sincerely thank you for selecting a product from Evolution Power Tools.

EVOLUTION LIMITED GUARANTEE

Evolution Power Tools reserves the right to make improvements and modifications to the product design without prior notice. Please refer to the guarantee registration leaflet and/or the packaging for details of the terms and conditions of the guarantee.

The guarantee below is applicable to machines destined for the UK mainland market only. Other markets may have specific requirements, additions or exclusions applied. Consult your dealer for details of the guarantee applied to your area/country. All Evolution guarantees are in addition to your statutory rights.

(1.5)

Evolution Power Tools will, within the guarantee period, and from the original date of purchase, repair or replace any goods found to be defective in materials or workmanship. This guarantee is void if the tool being returned has been used beyond the recommendations in the instruction manual or if the machine has been damaged by accident, neglect, or improper service. This guarantee does not apply to machines and / or components which have been altered, changed, or modified in any way, or subjected to use beyond recommended capacities and specifications. Electrical components are subject to respective manufacturers' warranties. All goods returned defective shall be returned prepaid freight to Evolution Power Tools. Evolution Power Tools reserves the right to optionally repair or replace it with the same or equivalent item. There is no warranty – written or verbal – for consumable accessories such as (following list not exhaustive) blades, cutters, drills, chisels or paddles etc. In no event shall Evolution Power Tools be liable for loss or damage resulting directly or indirectly from the use of our merchandise or from any other cause. Evolution Power Tools is not liable for any costs incurred on such goods or consequential damages. No officer, employee or agent of Evolution Power Tools is authorized to make oral representations of fitness or to waive any of the foregoing terms of sale and none shall be binding on Evolution Power Tools.

Questions relating to this limited guarantee should be directed to the company's head office, or call the appropriate helpline number.

MACHINE SPECIFICATIONS

MACHINE	METRIC	IMPERIAL
Motor (230-240V ~ 50 Hz)	1200W	5A
Motor (110V ~ 50 Hz)	1200W	11A
Speed No Load	3750min ⁻¹	3750rpm
Weight (Net)	5.8 kg	12.8 lb
Dust Port Diameter	35mm	1-3/8 In.
Tool Dimensions (H x W x L) (0° / 0°) <small>(Note: Dimensions taken with saw head down.)</small>	260 x 393 x 381mm	10-15/64 x 15-15/32 x 15 In.
Cable Length	2m	6ft 9/16 In.

CUTTING CAPACITIES	METRIC	IMPERIAL
Mild Steel Plate - Max Thickness	6mm	1/4 In.
Mild Steel Box Section - Max Wall Thickness*	4mm	5/32 In.
Wood – Max section	125 x 55mm	4-15/16 x 2-3/16 In.

MAXIMUM CUTTING ANGLES	LEFT	RIGHT
Mitre	50°	50°
Bevel	0° - 45°	N/A

MITRE	BEVEL	MAX WIDTH OF CUT	MAX DEPTH OF CUT
0°	0°	125mm (4-15/16 In.)	55mm (2-3/16 In.)
0°	45°	125mm (4-15/16 In.)	35mm (1-3/8 In.)
45°	0°	85mm (3-3/8 In.)	55mm (2-3/16 In.)
45°	45°	85mm (3-3/8 In.)	35mm (1-3/8 In.)

BLADE DIMENSIONS	METRIC	IMPERIAL
Diameter	210mm	8-1/4 In.
Bore	25.4mm	1 In.
Thickness	1.7mm	1/16 In.

NOISE DATA	
Sound Pressure L _{pA}	110v: 96.02dB / 230v: 97.14dB
Sound Power Level L _{WA}	110v: 109.02dB / 230v: 110.14dB

*50mm mild steel box section.

Warning: Wear hearing protection!

Handling

- Handle the machine with care, allowing the machine to do the work.
- Avoid using excessive physical effort on any of the machines controls.
- Consider your security and stability, and the orientation of the machine during use.

Work Surface

- Consider the work surface material; its condition, density, strength, rigidity and orientation.

WARNING: The vibration emission during actual use of the power tool can differ from the declared total value depending on the ways in which the tool is used. The need to identify safety measures and to protect the operator are based on an estimation of exposure in the actual conditions of use (taking account of all parts of the operating cycle, such as the times the tool is switched off, when it is running idle, in addition to trigger time).

(1.8)

LABELS & SYMBOLS

WARNING: Do not operate this machine if warning and/or instruction labels are missing or damaged. Contact Evolution Power Tools for replacement labels.

Note: All or some of the following symbols may appear in the manual or on the product.

Manufacturing Date Code

The manufacturing date code is the first part of the serial number, found on the motor housing of the machine. Evolution serial numbers begin with the abbreviation of the machine followed by a letter. A = January, B = February and so on. The following 2 numbers are the year of manufacture. 09 = 2009, 10 = 2010, etc. (Example of batch code: XXX-A10)

(1.9)

Symbol	Description
V	Volts
A	Amperes
Hz	Hertz
min ⁻¹	Speed
~	Alternating Current
n ₀	No Load Speed
	Wear Safety Goggles
	Wear Ear Protection
	Do Not Touch
	Wear Dust Protection
	Wear Safety Gloves
	Read Instructions
	CE Certification
	EAC Certification
	Triman - Waste Collection & Recycling
	Waste Electrical & Electronic Equipment
	Warning
	Protection Class II Double Insulated

(1.10)

INTENDED USE OF THIS POWER TOOL

WARNING: This product is a Compound Mitre Saw and has been designed to be used with special **Evolution** blades. Only use accessories designed for use in this machine and/or those recommended specifically by **Evolution Power Tools Ltd.**

WHEN FITTED WITH A CORRECT BLADE THIS MACHINE CAN BE USED TO CUT:

- Wood, Wood derived products (MDF, Chipboard, Plywood, Blockboard, Hardboard etc),
- Wood with nails,
- 50mm mild steel box section with 4mm wall at HB 200-220,
- 6mm mild steel plate at HB 200-220.

Note: Wood containing non galvanised nails or screws, with care, can be safely cut.

Note: Not recommended for cutting galvanised materials or wood with embedded galvanised nails. For cutting stainless steel we recommend Evolution dedicated stainless steel blades.

(1.11)

PROHIBITED USE OF THIS POWER TOOL

WARNING: This product is a Compound Mitre Saw and must only be used as such. It must not be modified in any way, or used to power any other equipment or drive any other accessories other than those mentioned in this Instruction Manual.

(1.13)

WARNING: This machine is not intended for use by persons (including children) with reduced physical, sensory or mental capabilities, or lack of experience and knowledge, unless they have been given supervision or instruction concerning the safe use of the machine by a person responsible for their safety and who is competent in its safe use.

Children should be supervised to ensure that they do not have access to, and are not allowed to play with, this machine.

SAFETY PRECAUTIONS

(1.14)

ELECTRICAL SAFETY

This machine is fitted with the correct moulded plug and mains lead for the designated market. If the mains lead or the plug are damaged in any way, they must be replaced with original replacement parts by a competent technician.

(1.15)

OUTDOOR USE

WARNING: For your protection if this tool is to be used outdoors it should not be exposed to rain, or used in damp locations. Do not place the tool on damp surfaces. Use a clean, dry workbench if available. For added protection use a residual current device (R.C.D.) that will interrupt the supply if the leakage current to earth exceeds 30mA for 30ms. Always check the operation of the residual current device (R.C.D.) before using the machine.

If an extension cable is required it must be a suitable type for use outdoors and so labelled. The manufacturers instructions should be followed when using an extension cable.

(2.1)

POWER TOOL GENERAL SAFETY INSTRUCTIONS

WARNING: Read all safety warnings and instructions. Failure to follow the warnings and instructions may result in electric shock, fire and/ or serious injury.

Note: This power tool should not be powered on continuously for a long time.

Save all warnings and instructions for future reference.

The term "power tool" in the warnings refers to your mains-operated (corded) power tool or battery-operated (cordless) power tool.

(2.2)

1) General Power Tool Safety Warnings**[Work area safety]**

- a)** Keep work area clean and well lit. Cluttered or dark areas invite accidents.
- b)** Do not operate power tools in explosive atmospheres, such as in the presence of flammable liquids, gasses or dust. Power tools create sparks which may ignite the dust or fumes.
- c)** Keep children and bystanders away while operating power tool. Distractions can cause you to lose control.
- d)** Do not use this machine in an enclosed room.

(2.3)

2) General Power Tool Safety Warnings**[Electrical Safety]**

- a)** Power tool plugs must match the outlet. Never modify the plug in any way. Do not use any adapter plugs with earthed (grounded) power tools. Unmodified plugs and matching outlets will reduce the risk of electric shock.
- b)** Avoid body contact with earthed or grounded surfaces, such as pipes, radiators, ranges and refrigerators.
There is an increased risk of electric shock if your body is earthed or grounded.
- c)** Do not expose power tools to rain or wet conditions. Water entering a power tool will increase the risk of electric shock.
- d)** Do not abuse the cord. Never use the cord for carrying, pulling or unplugging the power tool. Keep cord away from heat, oil, sharp edges or moving parts. Damaged or entangled cords increase the risk of electric shock.
- e)** When operating a power tool outdoors, use an extension cord suitable for outdoor use. Use of a cord suitable for outdoor use reduces the risk of electric shock.
- f)** If operating a power tool in a damp location is unavoidable, use a residual current device (RCD) protected supply.
Use of an RCD reduces the risk of electric shock.

(2.4)

3) General Power Tool Safety Warnings**[Personal Safety].**

- a)** Stay alert, watch what you are doing and use common sense when operating a power tool. Do not use a power tool while you are tired or under the influence of drugs, alcohol or medication. A moment of inattention while operating power tools may result in serious personal injury.
- b)** Use personal protective equipment. Always wear eye protection to prevent injury from sparks and chippings. Protective equipment such as dust masks, non-skid safety shoes, hard hat or hearing protection used for appropriate conditions will reduce personal injuries.
- c)** Prevent unintentional starting. Ensure the switch is in the off-position before connecting to power source and or battery pack, picking up or carrying the tool. Carrying power tools with your finger on the switch or energising the power tools that have the switch on invites accidents.
- d)** Remove any adjusting key or wrench before turning the power tool on. A wrench or key left attached to a rotating part of a power tool may result in personal injury .
- e)** Do not overreach. Keep proper footing and balance at all times. This enables better control of the power tool in unexpected situations.
- f)** Dress properly. Do not wear loose clothing or jewellery. Keep your hair, clothing and gloves away from moving parts. Loose clothes, jewellery or long hair can be caught in moving parts.
- g)** If devices are provided for the connection of dust extraction and collection facilities, ensure that these are connected and properly used. Use of dust collection can reduce dust-related hazards.
- h)** When cutting metal, gloves should be worn before handling to prevent from getting burnt from hot metal.

(2.5)

**4) General Power Tool Safety Warnings
[Power tool use and care].**

- a)** Do not force the power tool. Use the correct power tool for your application. The correct power tool will do the job better and safer at a rate for which it was designed.
- b)** Do not use the power tool if the switch does not turn it on or off. Any power tool that cannot be controlled with the switch is dangerous and must be repaired.
- c)** Disconnect the power tool from the power source and/or battery pack from the power tool before making any adjustments, changing accessories, or storing power tools. Such preventative safety measures reduce the risk of starting the power tool accidentally.
- d)** Store idle power tools out of the reach of children and do not allow persons unfamiliar with the power tool or these Instructions to operate the power tool. Power tools are dangerous in the hands of untrained users.
- e)** Maintain power tools. Check for misalignment or binding of moving parts, breakage of moving parts and any other condition that may affect the power tools operation. If damaged, have the power tool repaired before use. Many accidents are caused by poorly maintained power tools.
- f)** Keep cutting tools sharp and clean. Properly maintained cutting tools with sharp cutting edges are less likely to bind and are easier to control.
- g)** Use the power tool, accessories and tool bits etc. in accordance with these instructions, taking into account the working conditions and the work to be performed. Use of the power tool for operations different from those intended could result in a hazardous situation.

(2.6)

**5) General Power Tool Safety Warnings
[Service]**

- a)** Have your power tool serviced by a qualified repair person using only identical replacement parts. This will ensure that the safety of the power tool is maintained.

(2.7)

HEALTH ADVICE

WARNING: When using this machine, dust particles may be produced. In some instances, depending on the materials you are working with, this dust can be particularly harmful. If you suspect that paint on the surface of material you wish to cut contains lead, seek professional advice. Lead based paints should only be removed by a professional and you should not attempt to remove it yourself. Once the dust has been deposited on surfaces, hand to mouth contact can result in the ingestion of lead. Exposure to even low levels of lead can cause irreversible brain and nervous system damage. The young and unborn children are particularly vulnerable. You are advised to consider the risks associated with the materials you are working with and to reduce the risk of exposure. As some materials can produce dust that may be hazardous to your health, we recommend the use of an approved face mask with replaceable filters when using this machine.

You should always:

- Work in a well-ventilated area.
- Work with approved safety equipment, such as dust masks that are specially designed to filter microscopic particles.

(2.8)

WARNING: the operation of any power tool can result in foreign objects being thrown towards your eyes, which could result in severe eye damage. Before beginning power tool operation, always wear safety goggles or safety glasses with side shield or a full face shield where necessary.

(3.5)

MITRE SAW SPECIFIC SAFETY

The following specific safety instructions for Mitre Saws are based on the requirements of EN 61029-2-9:2012+A11.

BLADE SAFETY

WARNING: Rotating circular saw blades are extremely dangerous and can cause serious injury and amputation. Always keep fingers and hands at least 150mm away from the blade at all times. Never attempt to retrieve sawn material until the cutting head is in the raised position, the guard is fully closed and the saw blade has stopped rotating.

Only use saw blades that are recommended by the manufacturer and as detailed in this manual and that comply with the requirements of EN 847-1

Do Not use saw blades that are damaged or deformed as they could shatter and cause serious injury to the operator or bystanders.

Do Not use saw blades that are manufactured from high speed steel (HSS).

If the table insert becomes damaged or worn it must be replaced with an identical one available from the manufacturer as detailed in this manual.

(3.6)

PERSONAL PROTECTIVE EQUIPMENT (PPE)

Hearing protection should be worn in order to reduce the risk of induced hearing loss.

Eye protection should be worn in order to prevent the possibility of the loss of sight from ejected chippings.

Respiratory protection is also advised as some wood and wood type products especially MDF (Medium Density Fibreboard) can produce dust that can be hazardous to your health. We recommend the use of an approved face mask with replaceable filters when using this machine in addition to using the dust extraction facility.

Gloves should be worn when handling blades or rough material. It is recommended that saw blades should be carried in a holder

wherever practicable. It is not advisable to wear gloves when operating the mitre saw.

(3.7)

SAFE OPERATION

Always ensure that you have selected the correct saw blade for the material being cut.

Do Not use this mitre saw to cut materials other than those specified in this Instruction Manual.

When transporting a mitre saw ensure that the cutting head is locked in the 90 degree down position (if a sliding mitre saw ensure that the slide bars are locked). Lift the machine by gripping the outer edges of the base with both hands (if a sliding mitre saw, transport using the handles provided). Under no circumstances shall the machine be lifted or transported using the retractable guard or any part of its operating mechanism.

Bystanders and other colleagues must be kept at a safe distance from this saw. Cut debris can, in some circumstances, be ejected forcibly from the machine, posing a safety hazard to people standing nearby.

Before each use check the operation of the retractable guard and its operating mechanism ensuring that there is no damage, and that all moving parts operate smoothly and correctly. Keep the work bench and floor area clear of all debris including sawdust, chips and off-cuts. Always check and ensure that the speed marked on the saw blade is at least equal to the no load speed marked on the mitre saw. Under no circumstances shall a saw blade be used that is marked with a speed that is less than the no load speed marked on the mitre saw.

Where it is necessary to use spacer or reducing rings these must be suitable for the intended purpose and only as recommended by the manufacturer.

If the mitre saw is fitted with a laser it shall not be replaced with a different type. If the laser

fails to operate it shall be repaired or replaced by the manufacturer or his authorised agent. The saw blade shall only be replaced as detailed in this Instruction Manual.

Never attempt to retrieve off-cuts or any other part of the work piece until the cutting head is in the raised position, the guard is fully closed and the saw blade has stopped rotating.

(3.8)

PERFORM CUTS CORRECTLY AND SAFELY

Wherever practicable always secure the work piece to the saw table using the work clamp where provided.

Always ensure that before each cut the mitre saw is mounted in a stable position.

If needed the mitre saw can be mounted on a wooden base or work bench or attached to a mitre saw stand as detailed in this Instruction Manual.

Long work pieces should be supported on the work supports provided or on appropriate additional work supports.

(3.9)

ADDITIONAL SAFETY ADVICE - CARRYING YOUR MITRE SAW

- Although compact, this Mitre Saw is heavy. To reduce the risk of back injury, get competent help whenever you have to lift the saw.
- To reduce the risk of back injury, hold the tool close to your body when lifting. Bending your knees so you can lift with your legs, not your back. Lift by using the handhold areas at each side of the machines base.
- Never carry the Mitre Saw by the power cord. Carrying the Mitre Saw by the power cord could cause damage to the insulation or the wire connections resulting in electric shock or fire.
- Before moving the Mitre Saw tighten the mitre and bevel locking screws and the sliding carriage locking screw to guard against sudden unexpected movement.

- Lock the Cutting Head in its lowest position. Ensure that the Cutting Head Locking Pin is completely engaged in its socket.

WARNING: Do not use the blade guard as a 'lifting point'. The power cord must be removed from the power supply before attempting to move the machine.

- Lock the Cutting Head in the down position using the Cutting Head Locking Pin.
- Loosen the Mitre Angle Locking Screw. Turn the table to either of its maximum settings.
- Lock the table in position using the Locking Screw.
- Use the two carry handle cut-outs machined into either side of the machine base, to transport the machine.

Place the saw on a secure stationary work surface and check the saw over carefully.

Check particularly the operation of all the machines safety features before attempting to operate the machine.

(4.1)

GETTING STARTED

UNPACKING

Caution: This packaging contains sharp objects. Take care when unpacking. Remove the machine, together with the accessories supplied from the packaging. Check carefully to ensure that the machine is in good condition and account for all the accessories listed in this manual. Also make sure that all the accessories are complete. If any parts are found to be missing, the machine and its accessories should be returned together in their original packaging to the retailer. Do not throw the packaging away; keep it safe throughout the guarantee period. Dispose of the packaging in an environmentally responsible manner. Recycle if possible. Do not let children play with empty plastic bags due to the risk of suffocation.

SERIAL NO. / BATCH CODE

Note: The serial number can be found on the motor housing of the machine. For instructions on how to identify the batch code, please contact the Evolution Power Tools helpline or go to: www.evolutionpowertools.com

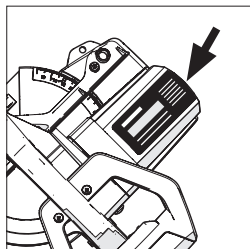

(4.2)

ITEMS SUPPLIED

Description	Quantity
Instruction Manual	1
RAGE Multipurpose TCT Blade	1
Top Hold Down Clamp	1
6mm Blade Change Allen Key	1

(4.3)

ADDITIONAL ACCESSORIES

In addition to the standard items supplied with this machine the following accessories are also available from the Evolution online shop at www.evolutionpowertools.com or from your local retailer.

(4.4)

Description	Part No
RAGE Multipurpose TCT Blade	RAGEBLADE210MULTI
Dust Bag	030-0309

MACHINE OVERVIEW

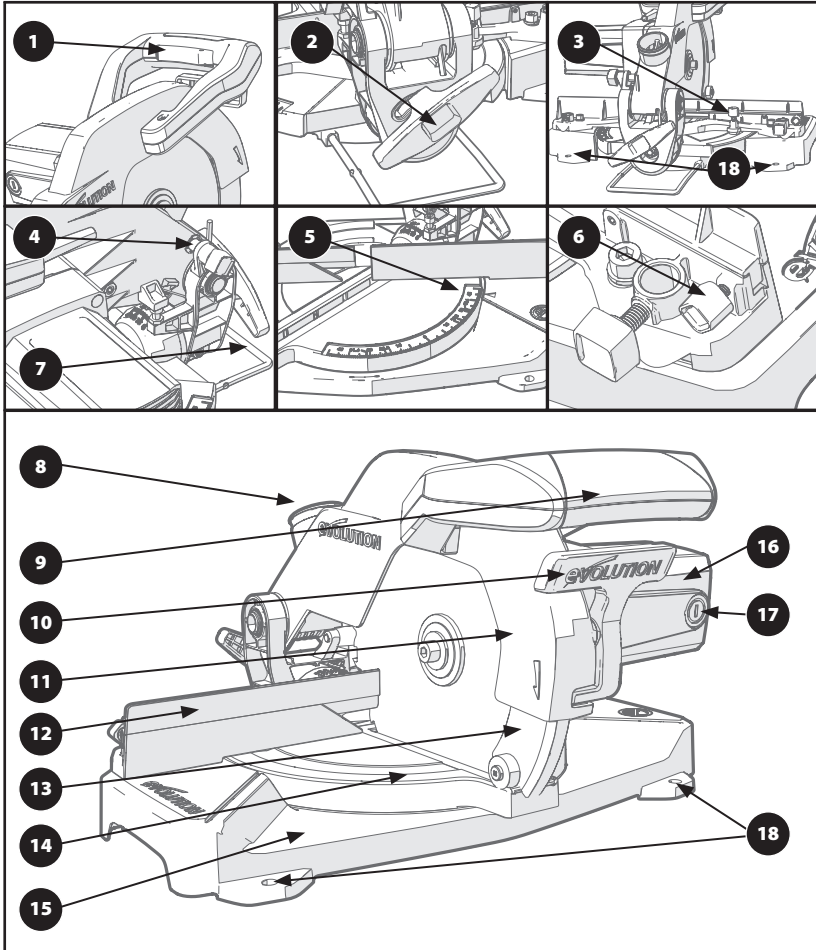

- 1. ON/OFF TRIGGER SWITCH**
- 2. BEVEL LOCKING HANDLE**
- 3. MITRE LOCKING SCREW**
- 4. HEAD LATCHING PIN**
- 5. MITRE ANGLE SCALE**
- 6. SLIDING FENCE LOCKING SCREW**
- 7. REAR STABILISING ARM**
- 8. DUST EXTRACTION PORT**
- 9. CUTTING HEAD HANDLE**

- 10. BLADE GUARD LOCKING LEVER**
- 11. UPPER BLADE GUARD**
- 12. SLIDING FENCE**
- 13. LOWER BLADE GUARD**
- 14. ROTARY TABLE**
- 15. MACHINE BASE/TABLE TOP**
- 16. MOTOR HOUSING**
- 17. CARBON BRUSHES**
- 18. MOUNTING HOLE (x4)**

(7.1)

ASSEMBLY AND PREPARATION

WARNING: Always disconnect the saw from the power source before making any adjustments.

(7.2)

PERMANENTLY MOUNTING THE MITRE SAW

To reduce the risk of injury from unexpected saw movement, place the saw in the desired location either on a workbench or other suitable machine stand. The base of the saw has four mounting holes through which suitable bolts (not supplied) can be placed to secure the mitre saw. If the saw is to be used in one location, permanently fasten it to the workbench using appropriate fastenings (not supplied). Use locking washers and nuts on the underside of the workbench (**Fig. 1**).

- To avoid injury from flying debris, position the saw so that other people or bystanders cannot stand too close (or behind) it.
- Locate the saw on a firm, level surface where there is plenty of room for handling and properly supporting the workpiece.
- Support the saw so the machine table is level and the saw does not rock.

Bolt or clamp the saw securely to its support stand or workbench.

(7.3)

FOR PORTABLE USE

- Mount the saw on a 18mm thick piece of plywood or MDF (800mm x 500mm min size recommended) using appropriate fastenings (not supplied).
- It may be necessary to countersink the washers, nuts, etc. to the underside of the plywood or MDF mounting board to avoid an uneven work surface.
- Use G-clamps to attach the mounting board to the work surface (**Fig. 2**).

Note: Some machines are fitted with a rear stabilizing arm found just below the bevel pivot.

If so fitted, this arm should be deployed/withdrawn from the base, particularly if the machine is to be used free standing on a work bench (**Fig. 3**).

This arm will provide extra stability to prevent the machine from tumbling in the event of sudden release of the cutting head.

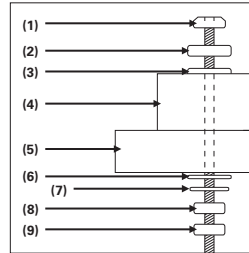

Fig. 1

- (1) Hex headed bolt
- (2) Spring washer
- (3) Flat washer
- (4) Mitre saw base
- (5) Workbench
- (6) Flat washer
- (7) Spring washer
- (8) Hex nut
- (9) Lock nut

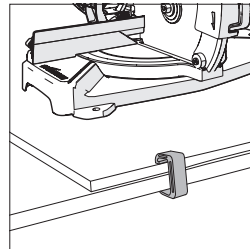

Fig. 2

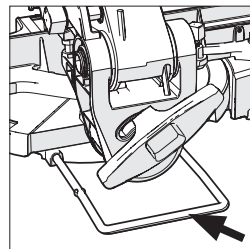

Fig. 3

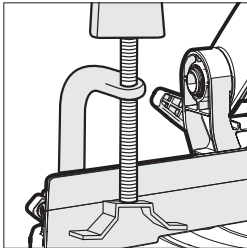

Fig. 4

(7.4)

HOLD DOWN CLAMP (Fig. 4)

Two sockets (one either side) are incorporated into the rear of the machines fence. These sockets are for positioning the top hold down clamp.

- Fit the clamp to the retaining socket that best suits the cutting application, ensuring that it is fully pushed down.
- Place the workpiece to be cut onto the saw rotary table, against the fence and in the desired position.
- Adjust the clamp using hand-wheel so that it securely holds the workpiece to the saw table.

Conduct a 'dry run' with the power disconnected. Ensure that the top hold down clamp does not interfere with the path of the blade, or with the path of any other part of the cutting head as it is lowered.

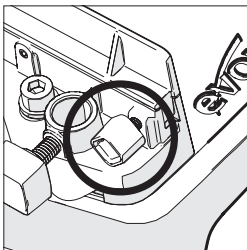

Fig. 5

THE SLIDING UPPER FENCE SECTION

Note: The left hand side of the fence has an adjustable upper section. When some acute mitre or bevel angles are selected it may be necessary to slide the upper portion of the fence to the left. This should normally create the clearance necessary to allow the cutting head and blade to be lowered without them fouling any other parts of the machine.

To adjust the fence:

- Loosen the thumbscrew (**Fig. 5**).
- Slide the upper section of the fence left to the required position and tighten the thumbscrew.
- Conduct a 'dry run' with the machine disconnected from the power supply to confirm that there is no interference between machine parts as the cutting head is lowered.

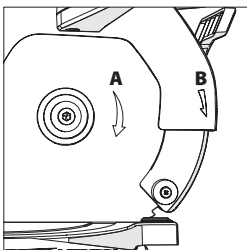

Fig. 6

(8.1)

OPERATING INSTRUCTIONS

Caution: The mitre saw should be inspected (particularly for the correct functioning of the safety guards) before each use. Do not connect the saw to the power supply until a safety inspection has been carried out.

Ensure that the operator is adequately trained in the use, adjustment and maintenance of the machine, before connecting to the power supply and operating the saw.

(8.2)

WARNING: To reduce the risk of injury, always unplug the saw before changing or adjusting any of the machines parts. Compare the direction of the rotation arrow on the guard to the direction arrow on the blade. The blade teeth should always point downward at the front of the saw (**Fig.6**). Check the tightness of the arbor screw.

(8.3)

BODY AND HAND POSITIONING (Fig. 7)

- Never place your hands within the 'No Hands Zone' (at least 150mm away from the blade). Keep hands away from the path of the blade.
- Secure the workpiece firmly to the table and against the fence to prevent any movement.
- Use a top hold down clamp if possible but check that it is so positioned that it does not interfere with the path of the blade or other moving machine parts.
- Avoid awkward operations and hand positions where a sudden slip could cause your fingers or a hand to move into the blade.
- Before attempting a cut, make a 'dry run' with the power off so that you can see the path of the blade.
- Keep your hands in position until the ON/OFF trigger switch has been released and the blade has completely stopped.

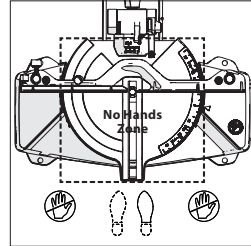

Fig. 7

(8.4)

ADJUSTMENT OF PRECISION ANGLES

Several checks/adjustments are possible on this machine. The operator will require a 45°/45°/90° set square (not supplied) to carry out these checks and adjustments.

WARNING: Checks/adjustments must only be conducted with the machine disconnected from the power supply.

BEVEL ANGLES (0° & 45°)

0° Bevel Stop Adjustment

- Ensure that the cutting head is in the locked down position with the latching pin fully engaged in its socket (see Fig.16).
- Ensure that the cutting head is upright, against its stop and the bevel pointer is indicating 0° on the scale (Fig. 8).
- Place the set square on the table with one short edge against the table and the other short edge against the blade (avoiding the TCT tips of the blade teeth) (Fig. 9).
- If the blade is not at 90° (square) with the mitre table, adjustment is required.
- Loosen the bevel locking handle and tilt the cutting head to the left.
- Loosen the locknut on the bevel angle adjustment screw with a 10mm spanner and 3mm Hex key (Not supplied) (Fig. 10).
- Use the Hex key to turn the screw in or out to adjust the blade angle.
- Return the cutting head to its upright position and recheck the angular alignment against the set square.
- Repeat the above steps until correct angular alignment is achieved.
- Tighten the bevel angle adjustment locknut securely.

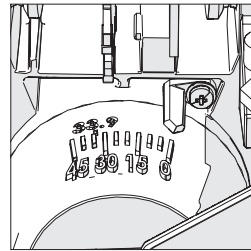

Fig. 8

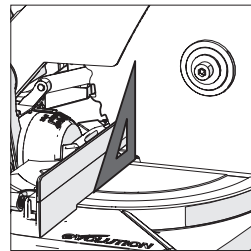

Fig. 9

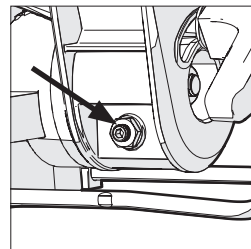

Fig. 10

EN

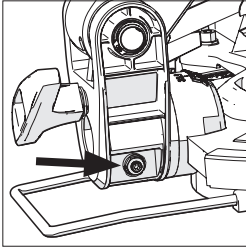

Fig. 11

45° Bevel Stop Adjustment

- Loosen the bevel locking handle and tilt the cutting head completely to the left until it rests against the 45° stop.
- Use a set square (avoiding the TCT tips of the blade teeth), check that the blade is at 45° to the table.
- If the saw blade is not in exact alignment adjustment is necessary.
- Return the cutting head to its upright position.
- Loosen the locknut on the 45° bevel adjustment screw with a 10mm spanner and 3mm Hex key (Not supplied).
- Use the Hex key to adjust the adjustment screw in or out as required (**Fig. 11**).
- Tilt the cutting head to the 45° setting and recheck for alignment with the set square.
- Repeat the above steps until the correct angular alignment is achieved.
- Tighten the adjustment screw locknut securely once alignment is achieved.

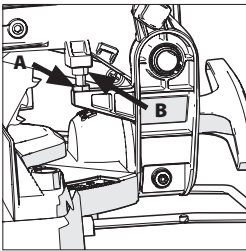

Fig. 12A + 12B

CUTTING HEAD TRAVEL

Cutting Head Downward Travel Adjustment

To prevent the blade from contacting any part of the machines metal base the downward travel of the cutting head can be adjusted. Lower the cutting head and check for any blade contact with the machines base.

If the downward travel of the cutting head needs to be adjusted:

- Loosen the locknut on the downward travel stop screw with a 10mm spanner (Not supplied) (**Fig. 12A**).
- Turn the adjusting screw (**Fig. 12B**) out (counter-clockwise) with a 5mm Hex key (Not supplied) to decrease the downwards travel of the cutting head.
- Turn the adjusting screw in (clockwise) to increase the downwards travel of the cutting head.
- Tighten the adjustment screw locknut when satisfactory downward travel of the cutting head is achieved.

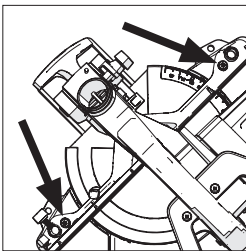

Fig. 13

FENCE ALIGNMENT

The fence must be aligned at 90° (square) to a correctly installed blade. The rotary table must be set at 0° mitre angle.

Note: The fence is fastened to the machines base with two socket head Hex screws positioned at either end of the fence in elongated slots (**Fig. 13**).

- Ensure that the cutting head is in the locked down position with the latching pin fully engaged in its socket (**Fig. 16**).
- Place a set square on the table with one short edge against the fence and the other short edge against the blade (avoiding the TCT tips of the blade teeth) (**Fig. 14**).
- Repeat on both sides of the blade.

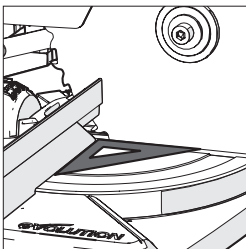

Fig. 14

- If adjustment is necessary, loosen the two fence attachment screws using a 5mm Hex key (Not supplied).
- Re-position the fence in its elongated slots until alignment is achieved.
- Securely tighten the socket head Hex screws.

MITRE ANGLE SCALES & POINTER

Note: There are dual mitre angle scales cast into the RH (Right Hand) side of the rotary table. A small pointer machined into the machines base indicates the angle selected (**Fig. 15**).

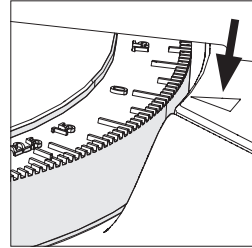

Fig. 15

FINAL ADJUSTMENT CHECKS

With the machine switched OFF and disconnected from the mains supply carry out the following (when all adjustments have been made);

- Set the machine at each of the maximum settings.
- Lower the blade to its lowest position and rotate the blade by hand, (it is advisable to wear gloves whilst doing this), and ensure that the blade does not foul on any part of the machine castings or guards.

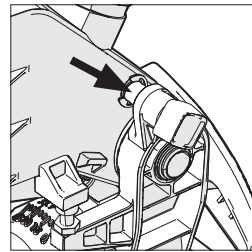

Fig. 16

(8.5)

PREPARING TO MAKE A CUT

WARNING: Do not over-reach.

Keep good footing and balance. Stand to one side so that your face and body are out of line of a possible kickback.

Freehand cutting is a major cause of accidents and should not be attempted.

- Ensure that the workpiece is always firmly resting against the fence, and where practical is clamped with the top hold down clamp to the table.
- The saw table should be clean and free from any sawdust, etc, before the workpiece is clamped into position.
- Ensure that the 'cut-off' material is free to move sideways away from the blade when the cut is completed. Ensure that the 'cut-off' piece cannot become 'jammed' in any other part of the machine.
- Do not use this saw to cut small pieces. If the workpiece being cut would cause your hand or fingers to be within 150mm of the blade, the workpiece is too small.

(8.6)

RELEASING THE CUTTING HEAD

The Cutting Head will automatically rise to the upper position once it is released from the locked down position.

It will automatically lock in the upper position.

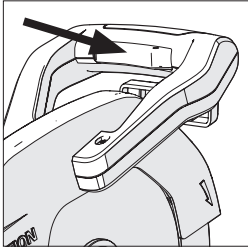

Fig. 17

To release the cutting head from the locked down position:

- Gently press down on the cutting handle.
- Pull out the head latching pin (**Fig. 16**) and allow the cutting head to rise to its upper position.

If release is difficult:

- Gently rock the cutting head up and down.
- At the same time twist the head latching pin clockwise and pull outwards.

Note: We recommend that when the machine is not in use the cutting head is locked in its down position with the latching pin fully engaged in its socket.

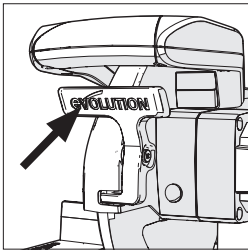

Fig. 18

THE MOTOR ON/OFF SWITCH (Fig. 17)

The ON/OFF motor trigger switch is a non-latching type. It is positioned inside the cutting handle.

- Press the switch to start the motor.
- Release the switch to turn off the motor.

CHOP CUTTING

This type of cut is used mainly for cutting small or narrow section material. The cutting head is gently pushed down to cut through the workpiece.

- Place the workpiece on the table and against the fence and secure with clamp(s) as appropriate.
- Take hold of the cutting handle.
- Turn the motor on and allow the saw blade to reach full speed.
- Press the lower guard locking lever to release the cutting head (**Fig. 18**).
- Lower the cutting handle downwards and cut through the workpiece.
- Allow the speed of the blade to do the work, there is no need to apply undue pressure to the cutting handle.
- When the cut has been completed, release the ON/OFF trigger switch.
- Allow the blade to come to a complete stop.
- Allow the cutting head to rise to its upper position, with the lower blade guard completely covering the blade teeth, and the cutting head locked in the upper position, before releasing the cutting handle.
- Remove the workpiece.

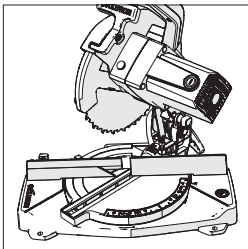

Fig. 19

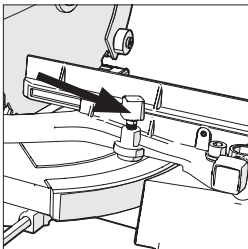

Fig. 20

MITRE CUTTING (Fig. 19)

The rotary table of this machine can be turned through 50° to the left or right from the normal cross-cut (0° mitre) position.

Positive stops are provided at 45°, 30°, 22.5°, 15°, and 0° to both the right hand and left hand sides.

- Loosen the mitre locking screw (**Fig. 20**) by turning it anti-clockwise.
- Turn the rotary table to the desired angle. A mitre angle protractor scale is incorporated into the rotary table to aid setting.
- Tighten the mitre locking screw when the desired angle is achieved.

WARNING: It is important (and good practice) to tighten the mitre locking screw even if a positive stop has been selected.

BEVEL CUTTING TILTING THE CUTTING HEAD

A bevel cut (**Fig. 21**) is made with the rotary table set at 0° mitre angle.

Note: To provide clearance for the moving cutting head and to accommodate the path of the blade, it may be necessary to adjust the upper section of the fence. (**See Page 16**)

The cutting head can be tilted from the normal 0° (perpendicular position) to a maximum angle of 45° from the perpendicular to the left hand side only.

To tilt the cutting head to the left:

- Loosen the bevel locking screw (**Fig. 22**).
- Tilt the cutting head to the required angle. A protractor scale is provided as an aid to setting (**Fig 23**).
- Tighten the bevel locking screw when the desired angle has been selected.

When cutting is completed:

- Release the ON/OFF trigger switch, but keep your hands in position and allow the blade to completely stop.
- Allow the cutting head to rise to its upper position, with the lower blade guard completely deployed before removing your hand(s).
- Return the cutting head to the perpendicular position.
- Tighten the bevel locking screw.

(8.7) COMPOUND CUTTING (**Fig. 24**)

A compound cut is a combination of a mitre and bevel cut employed simultaneously. When a compound cut is required, select the desired bevel and mitre positions as previously described. **WARNING:** Always check that the path of the blade does not interfere with the machines fence or any other parts of the machine. Conduct a 'dry run' with the machined disconnected from the power source.

Adjust the upper left hand section of the fence if necessary.

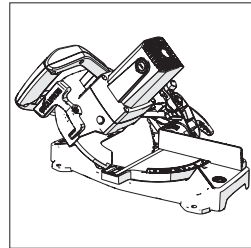

Fig. 21

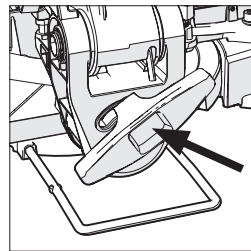

Fig. 22

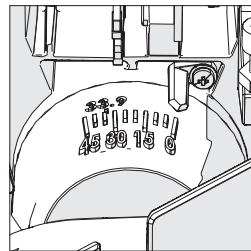

Fig. 23

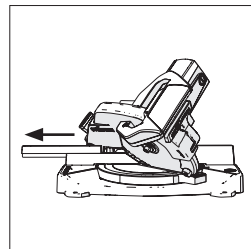

Fig. 24

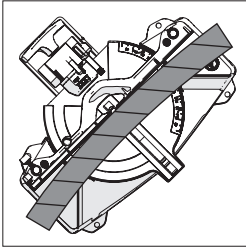

Fig. 25

(8.8)

CUTTING BOWED MATERIAL (Fig. 25)

Before cutting any workpiece, check to see if it is bowed. If it is bowed the workpiece must be positioned and cut as shown. Do not position the workpiece incorrectly or cut the workpiece without the support of the fence.

(8.9)

CLEARING JAMMED MATERIAL

- Turn mitre saw "OFF" by releasing the trigger switch.
- Allow the blade to come to a complete stop.
- Unplug the mitre saw from the mains supply.
- Carefully remove any jammed material from the machine.
- Check the condition and operation of the safety guard.
- Check for any other damage to any part of the machine e.g. the blade.
- Have any damaged parts replaced by a competent technician and a safety inspection carried out before using the machine again.

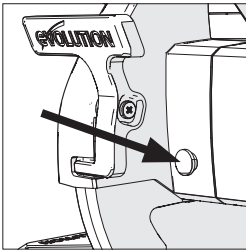

Fig. 26

(8.10)

SUPPORTING LONG WORKPIECES

The free end of a long workpiece should be supported at the same height as the machine table. The operator should consider using a remote workpiece support if thought necessary.

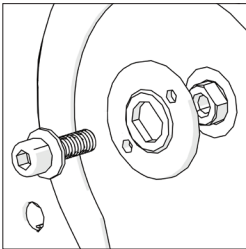

Fig. 27

(8.11)

INSTALLING OR REMOVING A BLADE

Warning: Only carry out this operation with the machine disconnected from the mains supply.

Note: It is recommended that the operator wears protective gloves when handling the blade during installation or when changing the machines blade.

Warning: Only use genuine Evolution blades or those blades specifically recommended by Evolution Power Tools and which are designed for this machine. Ensure that the maximum speed of the blade is higher than the speed of the machine's motor.

Note: Blade bore reducing inserts should only be used in accordance with the manufacturers instructions.

Warning: The arbor screw has a LH (Left Hand) thread.

Turn clockwise to loosen. Turn counterclockwise to tighten.

Press & keep pressing the arbor lock button on the motor housing while turning the arbor screw using the supplied hex key until the button locates fully into the shaft and locks the shaft (**Fig. 26**). Continue to remove the arbor screw, and outer blade flange (**Fig. 27**).

Release the arbor lock button.

- Ensure that the blade and blade flanges are clean and free from any contamination.
- The inner-blade flange should be left in place but if it is removed for cleaning it must be replaced the same way round as it was removed from the machine.

To insert the blade press the lower blade guard release trigger **(A)** rotate the lower blade guard **(B)** up into the upper blade guard and hold the lower blade guard in that position **(Fig. 28)**. Install the new blade onto the inner flange ensuring it is seated properly on the flange shoulder and then slowly release the lower blade guard back to its original closed position. Make sure the rotation arrow on the blade **(A)** matches the clockwise rotation arrow on the upper guard **(B)** **(Fig. 29)**. **Note:** The blade teeth should always point downward at the front of the saw.

Install the outer flange **(1)** (flat face onto the machine), washer **(2)** and arbor screw **(3)** **(Fig. 30)**.

Press & keep pressing the arbor lock button on the motor housing while tightening the arbor screw using the supplied hex key until the button locates fully into the shaft and locks the shaft **(Fig. 26)**.

Tighten the arbor screw using moderate force, but do not overtighten. Ensure the hex key is removed and the arbor lock button has released before operating. Ensure the blade guard is fully functional before using the machine.

(8.12)

USE OF OPTIONAL EVOLUTION ACCESSORIES

Not supplied as original equipment (see 'Additional Accessories').

(8.13) DUST BAG

A dust bag can be fitted to the extraction port at the rear of the machine. The dust bag is for use when cutting wooden materials only.

- Slide the dust bag over the dust extraction port, ensuring that the spring clip grips the port holding the dust bag securely in place **(Fig. 31)**.

Note: For operational efficiency empty the dust bag when it becomes 2/3 full. Dispose of the contents of the dust bag in an environmentally responsible way. It may be necessary to wear a dust mask when emptying the dust bag.

Note: A workshop vacuum extraction machine can be attached to the dust extraction port if required. Follow the vacuum manufacturers instructions if such a machine is fitted.

WARNING: Do not use the Dust Bag when cutting metallic materials.

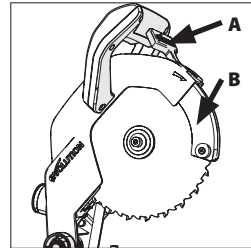

Fig. 28

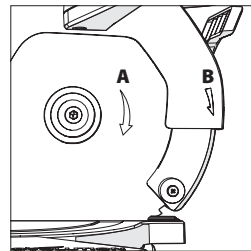

Fig. 29

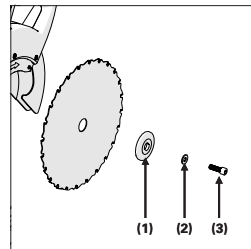

Fig. 30

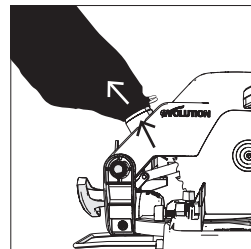

Fig. 31

(6.1)

MAINTENANCE

Note: Any maintenance must be carried out with the machine switched off and disconnected from the mains/battery power supply. Check that all safety features and guards operating correctly on a regular basis. Only use this machine if all guards/safety features are fully operational. All motor bearings in this machine are lubricated for life. No further lubrication is required.

Use a clean, slightly damp cloth to clean the plastic parts of the machine. Do not use solvents or similar products which could damage the plastic parts.

WARNING: Do not attempt to clean by inserting pointed objects through openings in the machines casings etc. The machines air vents should be cleaned using compressed dry air. Excessive sparking may indicate the presence of dirt in the motor or worn out carbon brushes.

(6.2)

If this is suspected have the machine serviced and the brushes replaced by a qualified technician.

(6.4)

ENVIRONMENTAL PROTECTION

Waste electrical products should not be disposed of with household waste. Please recycle where facilities exist. Check with your local authority or retailer for recycling advice.



EC DECLARATION OF CONFORMITY



The manufacturer of the product covered by this Declaration is:

Evolution Power Tools, Venture One, Longacre Close, Holbrook Industrial Estate, Sheffield, S20 3FR.

The manufacturer hereby declares that the machine as detailed in this declaration fulfils all the relevant provisions of the Machinery Directive and other appropriate directives as detailed below. The manufacture further declares that the machine as detailed in this declaration, where applicable, fulfils the relevant provisions of the Essential Health and Safety requirements.

The Directives covered by this Declaration are as detailed below:

- 2006/42/EC.** Machinery Directive.
- 2014/30/EU.** Electromagnetic Compatibility Directive.
- 2011/65/EU.** The Restriction of the Use of certain Hazardous Substances in Electrical Equipment (RoHS) Directive.
- 2012/19/EU.** The Waste Electrical and Electronic Equipment (WEEE) Directive.

And is in conformity with the applicable requirements of the following documents:

**EN61029-1:2009+A11 • EN 61029-2-9:2012+A11 • EN55014-1:2006+A1+A2
EN55014-2: 2015 • EN61000-3-2:2014 • EN61000-3-11: 2000 • EN ISO 12100:2010**

Product Details

Description: R210CMS 210mm MULTIPURPOSE COMPOUND MITRE SAW
 Evolution Model No: 230v: R210CMS / F210CMS / 046-0001 / 046-0001A / 046-0003
 046-0003A / 046-0006 / 046-0008
 110V: 046-0002 / 046-0002A / 046-0007
 Brand Name: EVOLUTION
 Voltage: 230-240V / 110V ~ 50 Hz
 Input: 1200W

The technical documentation required to demonstrate that the product meets the requirements of directive has been compiled and is available for inspection by the relevant enforcement authorities, and verifies that our technical file contains the documents listed above and that they are the correct standards for the product as detailed above.

Name and address of technical documentation holder.

Signed:  Print: Matthew Gavins: Group Chief Executive.

Date: 01/04/2016

The place of keeping technical documents: Venture One, Longacre Close, Sheffield, S20 3FR

evOLUTION[®]

www.evolutionpowertools.com

UK

Evolution Power Tools Ltd
Venture One
Longacre Close
Holbrook Industrial Estate
Sheffield
S20 3FR

+44 (0)114 251 1022

US

Evolution Power Tools LLC
8363 Research Drive
Davenport
Iowa
52806

+1 866-EVO-TOOL

EU

Evolution Power Tools SAS
61 Avenue Lafontaine
33560
Carbon-Blanc
Bordeaux

+ 33 (0)5 57 30 61 89

Discover Evolution Power Tools

Visit: www.evolutionpowertools.com
or download a QR Reader App on your
smart phone and scan the QR code (right).



R210CMS QR CODE